

Quadro 1 NEW = mm

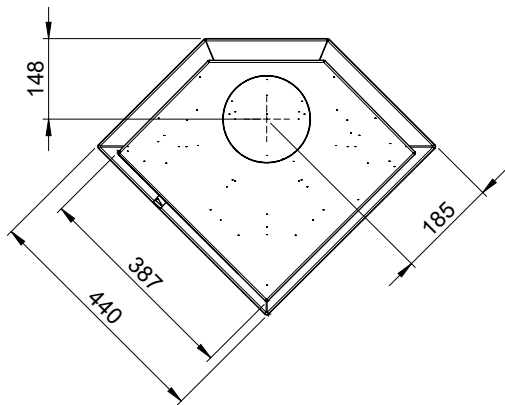

Quadro 2 NEW= mm

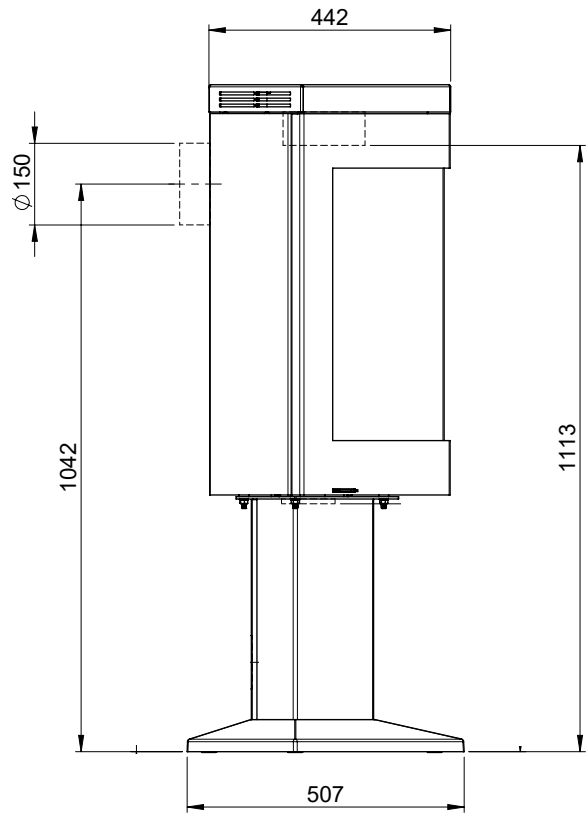
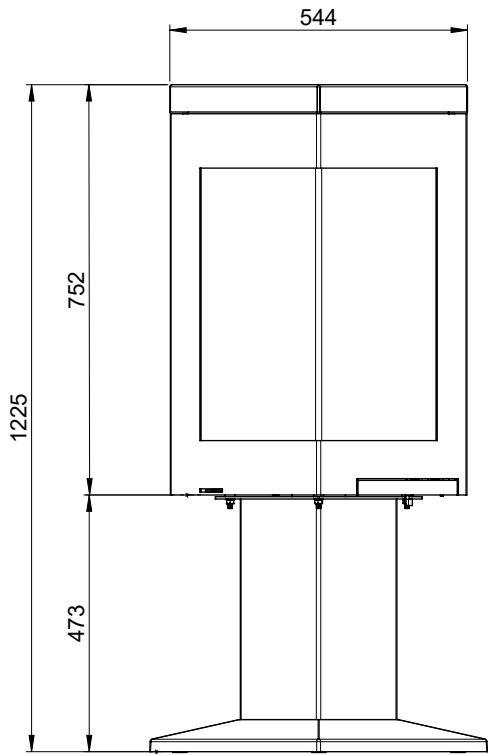
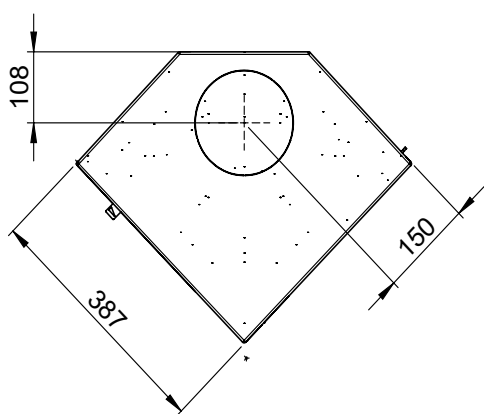
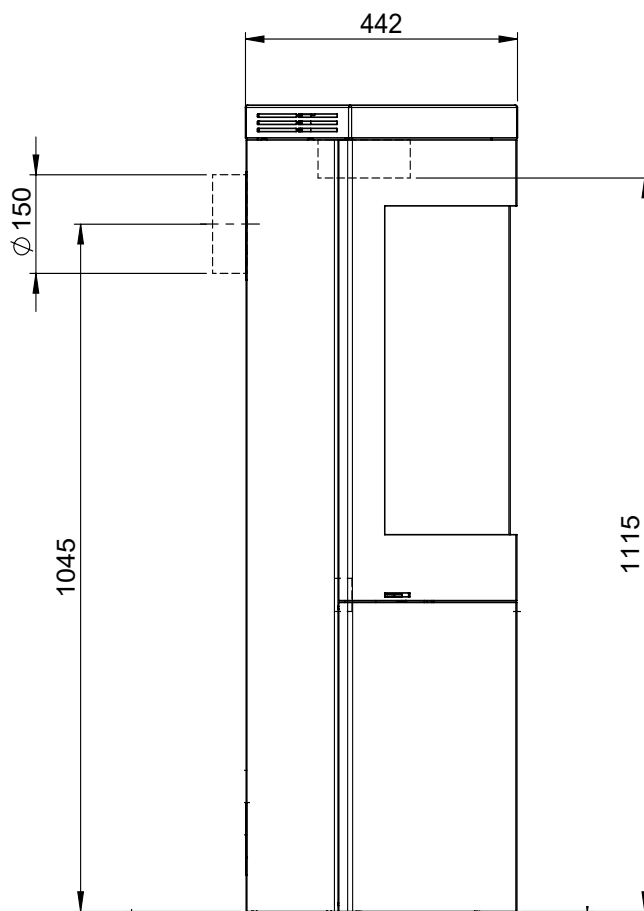
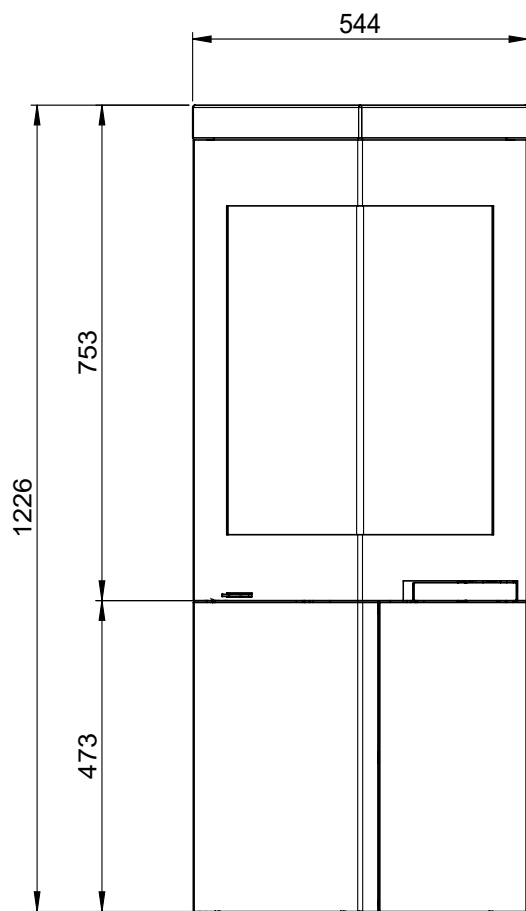

Quadro 3 NEW = mm

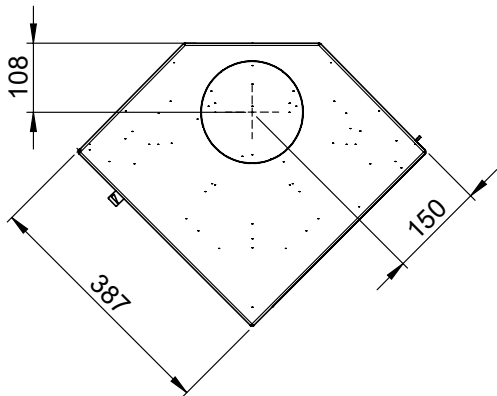
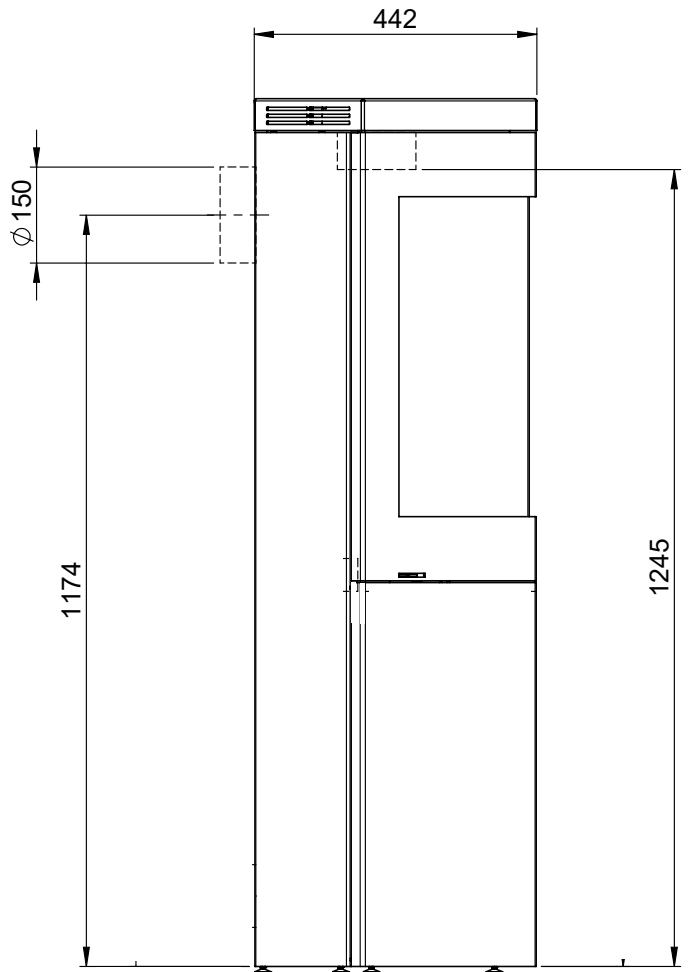
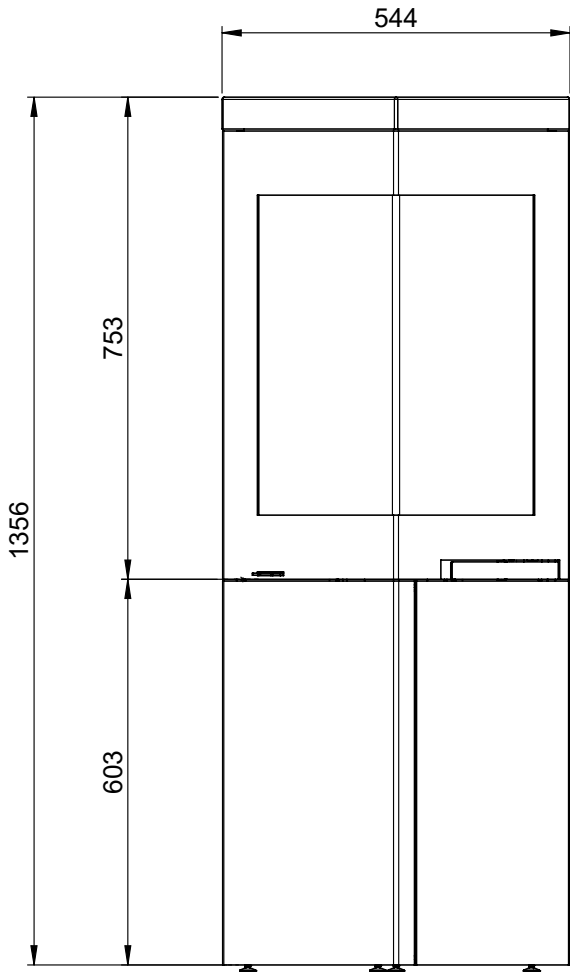

Quadro Air

Quadro 1

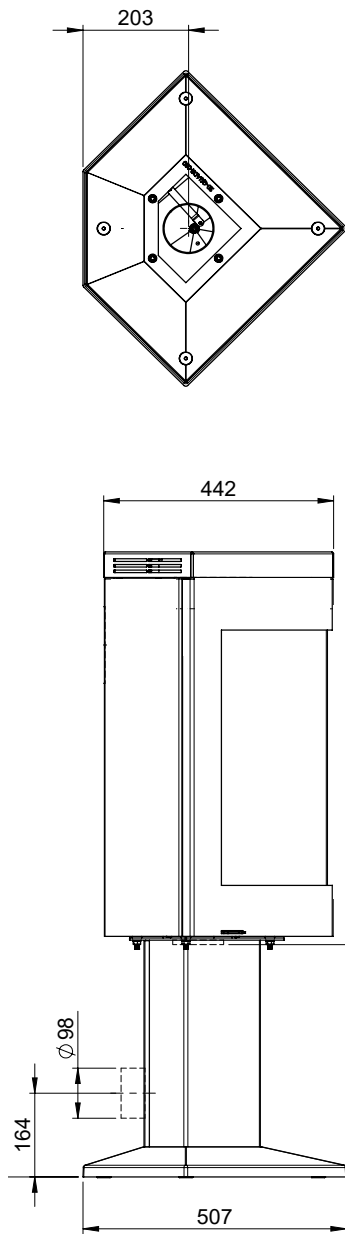

Quadro 2

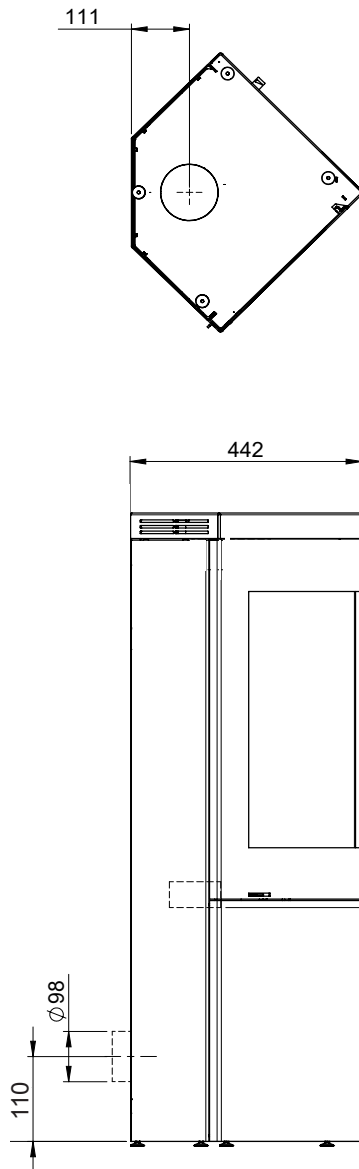

Quadro 3

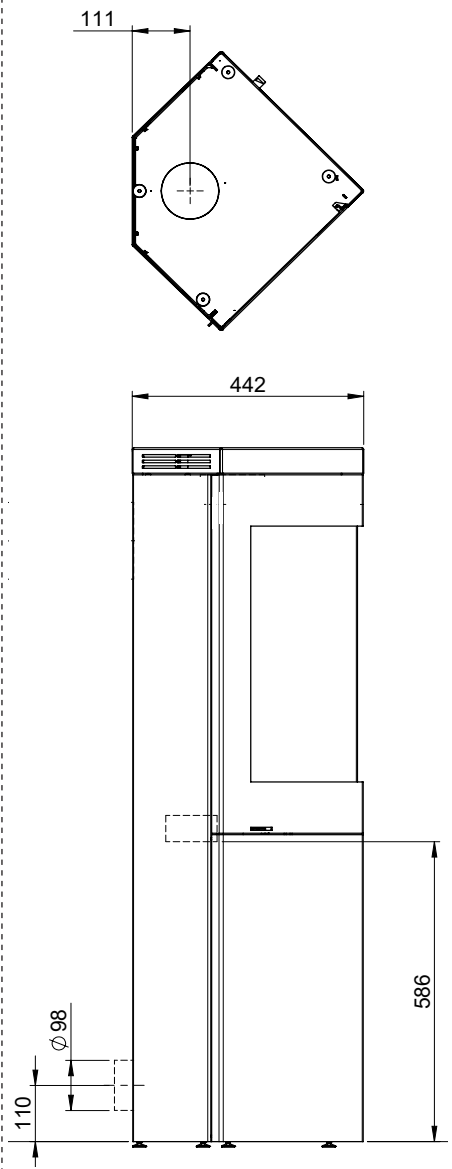



FIG 2 = mm

 =Brannmur/Brandmur/Palomuuri/Firewall

 =Brennbart materiale/Brændbart materiale/ Brännbart material/ Tulenarka materiaali/Combustible material

- (*) with insulated smoke pipe
- (*) med isolert røykrør
- (*) med isolerat rökrör
- (*) takaliitos eristetyllä liitosputkella

